

System Operating Manual

For use with list 11781-04

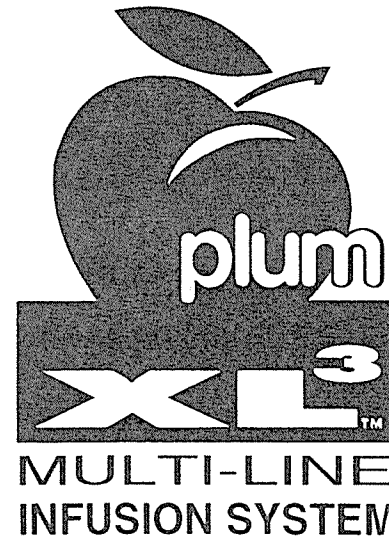
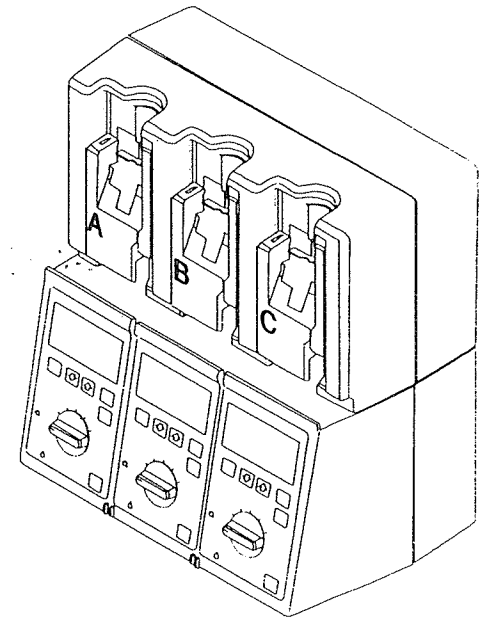

Abbott Laboratories
North Chicago, IL 60064
USA

430-94030-B01 (Rev. 1/97)



Abbott Laboratories

6.7	Clear Volume	29
6.8	Lockout	30
7.0	TROUBLESHOOTING	31
7.1	Alarms	31
7.2	Malfunctions	34
7.3	Technical Assistance	35
8.0	PRECAUTIONS	37
8.1	Artifacts	37
8.2	Healthcare Professional and Patient Related	37
8.3	Battery Operation	39
8.4	Sets and Accessories	39
8.5	Backpriming	40
8.6	General	40
9.0	CLEANING, MAINTENANCE, AND STORAGE	43
9.1	Cleaning and Sanitizing	43
9.2	Battery Maintenance	46
9.3	Storage	46
9.4	Service	47
10.0	SYSTEM ACCESSORIES	49
11.0	SPECIFICATIONS	50
12.0	WARRANTY	52

1.0 CONVENTIONS

This section describes the conventions used throughout this manual, as follows:

Convention	Application	Example
<i>Italic</i>	Reference to a section, figure, or table	(See Figure 3-1, Priming Cassette)
	Function or mode specific instructions	Primary Only: Attach an empty container..
[ALL CAPS]	Keys or touchswitches on the device are described all caps in brackets	[OFF CHARGE]
ALL CAPS Initial Caps lowercase	Screen displays and device labels (as appropriate)	TURN TO RUN
Bold	Emphasis	...sets are supplied Sterile and are for....

1.1 Warnings Cautions, and Notes

Alert messages used throughout this manual are described below. Pay particular attention to these messages.

WARNING

A WARNING MESSAGE CONTAINS SPECIAL SAFETY EMPHASIS AND MUST BE OBSERVED AT ALL TIMES. FAILURE TO OBSERVE A WARNING MESSAGE IS POTENTIALLY LIFE THREATENING.

© Copyright 1997 Abbott Laboratories All Rights Reserved

This document and the subject matter disclosed herein are proprietary information. Abbott Laboratories retains all the exclusive rights of dissemination, reproduction, manufacture and sale. Any party using this document accepts it in confidence, and agrees not to duplicate it in whole or in part nor disclose it to others without the written consent of Abbott Laboratories.

CAUTION: A CAUTION usually appears in front of a procedure or statement. It contains information that could prevent irreversible product damage or hardware failure. Neglecting to pay attention to a CAUTION could result in serious patient or user injury.

Note: A Note highlights information that helps explain a concept or procedure.



This symbol directs the user to consult accompanying documents.

Note: Figures are rendered as graphic representations to approximate the actual product; therefore, figures may not exactly reflect the product.

2.0 FEATURES

The Plum® XL3 Micro/Macro is a multi-line volumetric infusion system designed to meet the growing demand for hospital-wide standardization. The Plum XL3 houses three independent pumping units, each having a primary line, secondary line, and piggyback fluid delivery capability. The Plum XL3 is suited for a wide range of medical/surgical and critical care applications. Full compatibility with LifeCare® PlumSets® administration sets and accessories, and the LifeShield® needleless protection systems, makes the Plum XL3 a convenient and cost-effective infusion system.

The following features are included in the Plum XL3:

- Nonpulsatile volumetric accuracy
- Micro/Macro 0.1-999 mL/hr flow rate range
- Convenient Quickset™ Programming allows clinician to quickly increase rate and volume
- Microprocessor control
- Large LCD screen
- Panel back illumination on AC power
- Lockout Switch
- Wide range of standard and specialty administration sets
- Standard fullfill, partfill, syringe and vial use
- Parenteral, blood and nonparenteral (enteral) fluid delivery
- Anti free-flow protection
- Backpriming
- Titration

- KVO at dose end (1.0 mL/hr or less depending on delivery rate)
- Long battery life for emergency backup and temporary portable operation

2.1 User Qualification

The Plum XL3 infusion system is for use at the direction or under the supervision of licensed physicians or by licensed or certified healthcare professionals who are trained in the use of the Plum XL3 and the administration of parenteral or enteral fluids and drugs.

3.0 GETTING STARTED

This section describes the instrument installation procedures for the Plum XL3 Micro/Macro.

3.1 Unpacking

CAUTION: Product damage may occur unless proper care is exercised during unpacking and installation. Do not use the Plum XL3 if it appears damaged in any way. The battery may not be charged upon receipt.

Inspect the Plum XL3 packaging for visible shipping damage. If any damage is found, contact the delivering carrier immediately.

Carefully remove the Plum XL3 from the shipping carton. Retain the packing slip and save all packing material in case the Plum XL3 is damaged or fails the self-test and has to be returned to the manufacturer.

Inspect the Plum XL3 thoroughly for damage.

CAUTION: If the Plum XL3 appears to be damaged; contact Abbott Laboratories.

3.2 Self-Test

CAUTION: Do not place the Plum XL3 in service if it fails the self-test.

Connect the AC power cord to AC power, then confirm the AC power indicators illuminate (next to the OFF CHARGE setting). Place a primed administration set into the cassette door of a pumping unit (see *Section 5.0, INSTRUCTIONS FOR USE*). Close the cassette door.

After the cassette door is closed, turn the control dial to SET RATE.

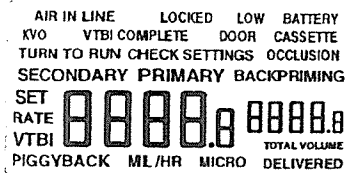

The LCD screen displays all the symbols briefly. Verify that the screen display exactly matches the illustration shown at the left. If the LCD screen does not match the illustration, remove the Plum XL3 from service and contact the hospital repair facility or Abbott Laboratories Technical Support Operations.

After the general LCD self-test, the LCD screen displays duplicated segments of the numeric display. Verify that the screen display alternates exactly as shown in the illustrations at the left. If the display does not match the illustrations, remove the Plum XL3 from service and contact the hospital repair facility or Abbott Laboratories Technical Support Operations.

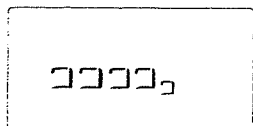
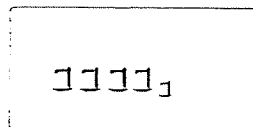

After the Plum XL3 completes self-testing, disconnect it from AC power and confirm that BATTERY displays on the screen (indicating battery power is in use). Repeat the procedure above for the remaining two pumping units.

CAUTION: Do not operate the Plum XL3 with the battery removed. The use of a properly maintained and charged battery ensures proper operation. As always, in the event of an AC power interruption or failure, verify infusion pump settings.

To ensure the battery is fully charged, remove the administration set, then reconnect the Plum XL3 to AC power for a minimum of six hours in the OFF CHARGE setting.

Note: If an alarm occurs during the self-test, note the message, then take the appropriate corrective action (see Section 7.0, TROUBLESHOOTING). Repeat the self-test. If the alarm recurs, remove the Plum XL3 from service and contact Abbott Laboratories Technical Support Operations.

4.0 COMPONENTS

The front and back of the Plum XL3 Micro/Macro components are illustrated below.

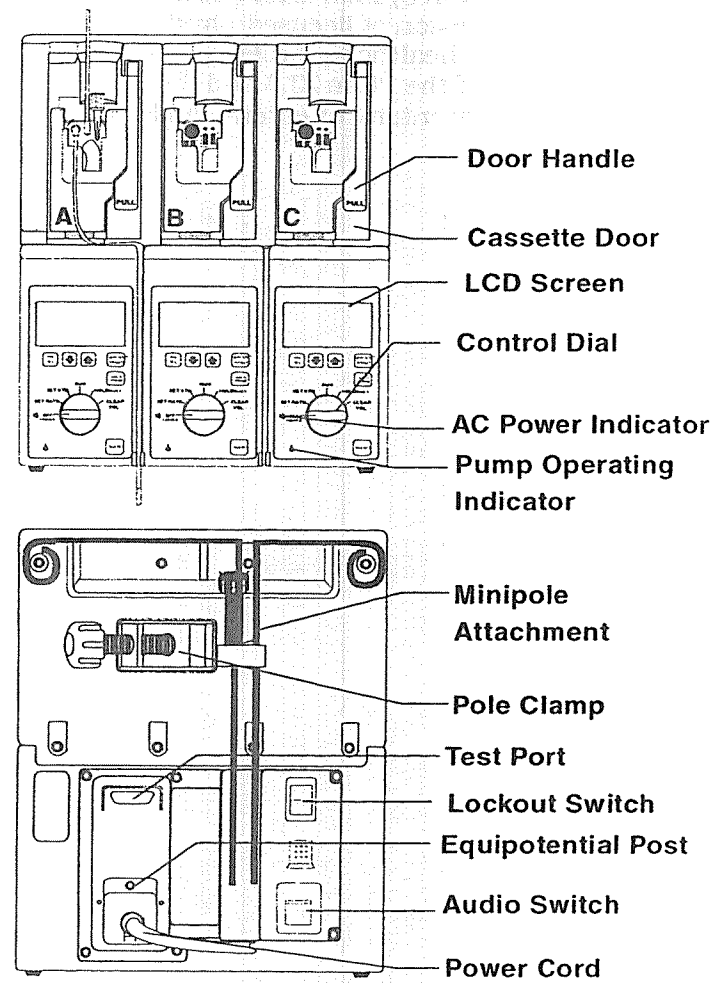

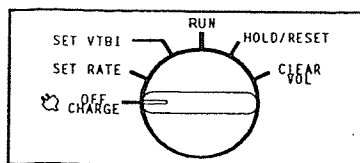

4.1 Control Dial Settings



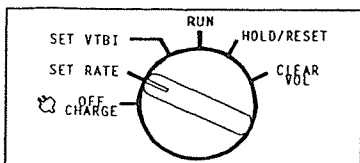

OFF CHARGE stops all active functions. The battery charges in any dial setting when the Plum XL3 is connected to AC power. Store the Plum XL3 in the OFF CHARGE setting and plugged into AC power.

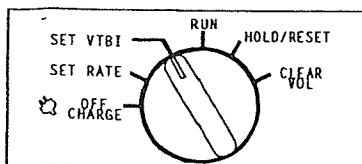

SET RATE sets the delivery rate for the primary or secondary line using the  or  key. The rate range is 0.1 to 99.9 mL/hr in 0.1-mL increments, then 100 to 999 mL/hr in 1-mL/hr increments.

Note: Use the [QUICKSET] key to quickly raise the rate to the next higher entry in this sequence: 0, 5.0, 25.0, 50.0, 75.0, 100, 125, 150, 200, 500, 999.



SET VTBI sets the volume to be infused/delivered (VTBI) from the primary or secondary line using the  or  key. The VTBI range is 0.1 to 99.9 mL in 0.1-mL increments, then 100 to 9999 mL in 1-mL increments.

Note: Use the [QUICKSET] key to quickly raise the VTBI to the next higher entry in this sequence: 0, 10.0, 25.0, 50.0, 100, 150, 250, 500, 1000, 2000, 3000, 4000, 9999.

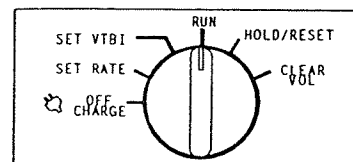

RUN starts fluid delivery at the rate set by the user. RUN is the only setting that delivers fluid. The pump operating indicator light on the front panel flashes during pumping.

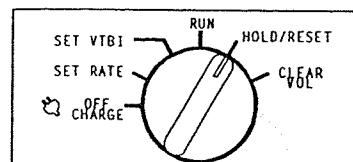

HOLD/RESET stops fluid delivery. Fluid containers can be changed in this setting. If the pumping unit is in an alarm condition, HOLD/RESET silences the audible alarm. Alarm messages are retained until control dial is returned to the RUN setting.

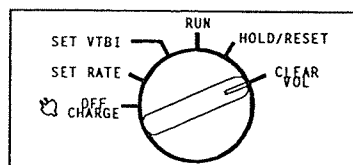

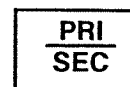

CLEAR VOL clears the total volume delivered. To avoid unintentional erasure of volumes, an alert sounds to allow the user to change the setting before the volumes are cleared (see Section 6.7, *Clear Volume*).

4.2 Operating Keys



[PRI-SEC] selects the fluid line to program. Press the [PRI-SEC] key when the control dial is in SET RATE or SET VTBI to toggle between the primary and secondary line.



[TITRATE] adjusts the fluid delivery rate up or down while pumping is in progress. Hold the [TITRATE] key while pressing the  or  key to increase or decrease the delivery rate.

QUICKSET
TITRATE

[QUICKSET] changes the rate to change in preprogrammed increments.

With the Plum XL3 in SET RATE mode, pressing the **[QUICKSET]** key causes the rate to change to the next higher entry in this sequence: 0, 5.0, 25.0, 50.0, 75.0, 100, 125, 150, 200, 500, 999.

With the instrument in VTBI mode, pressing the **[QUICKSET]** key causes VTBI to change to the next higher entry in this sequence: 0, 10.0, 25.0, 50.0, 100, 150, 250, 500, 1000, 2000, 3000, 4000, 9999.

BACK
PRIME

[BACKPRIME] clears any air accumulated in the cassette. Press the **[BACKPRIME]** key when the control dial is in HOLD/RESET to pump fluid from the primary line and expel the air into the secondary line. Backpriming is also used to reprime empty secondary tubing.

SILENCE

[SILENCE] temporarily mutes audible alarms. The alarm display and the LCD screen continue to flash. The audible alarm resumes after two minutes if the alarm condition is not corrected. To silence a Low Battery alarm, refer to the alarm tips in *Section 7.0, TROUBLESHOOTING*.

4.3 Additional Features



AUDIO SWITCH (located on the rear panel) has two sound level settings, high and low.



LOCKOUT SWITCH (located on the rear panel) may be used to prevent unauthorized changes to the Plum XL3 settings.

NOTES

5.0 INSTRUCTIONS FOR USE

This section describes the Plum XL3 Micro/Macro setup and cassette use.

5.1 Setup

To set up the Plum XL3, plug the power cord into an AC power outlet, unless temporary battery operation is desired.

Note: Use AC power whenever possible. Store the Plum XL3 connected to AC power to ensure a fully charged battery for emergency use.

Set the audio switch to the desired volume level, HIGH or LOW.

The Plum XL3 may be safely and conveniently mounted on an IV stand.

CAUTION: The XL3 system is designed to operate normally in the presence of most encountered EMF conditions. In the event of extreme levels of interference, such as encountered next to an electrosurgical generator, cellular telephones, or two-way radios, it is possible that the normal operation of a sensor or microcomputer might be disrupted. Operation of the infusion device under such conditions should be avoided.

5.2 Cassettes

The Plum XL3 is compatible with the wide range of PlumSets administration sets. Become familiar with the components illustrated in the following figure before preparing the cassette.

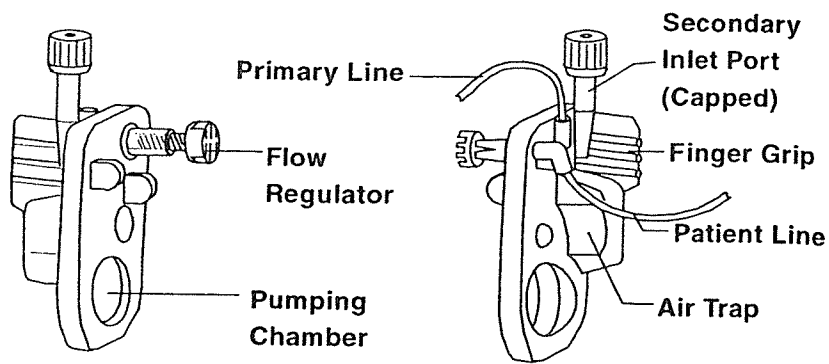

5.2.1 PREPARING THE CASSETTE

Use aseptic technique to prepare the cassette for priming, then proceed as follows:

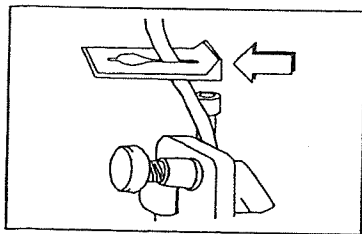

Close the upper clamp on the administration set.

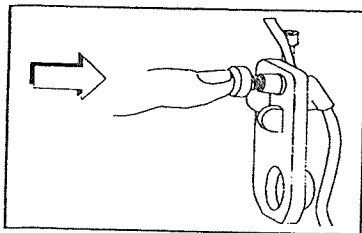

Push in the flow regulator to close it.

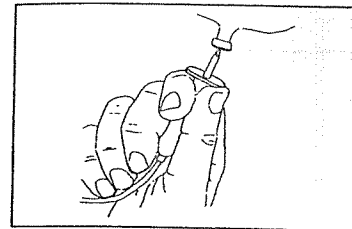

Expose the outlet of the IV container, then insert the piercing pin into the outlet with a twisting motion.

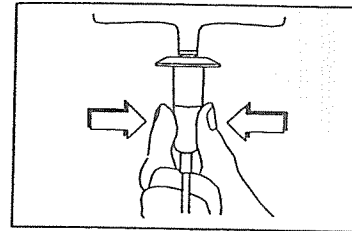

Fill the drip chamber to the score mark.

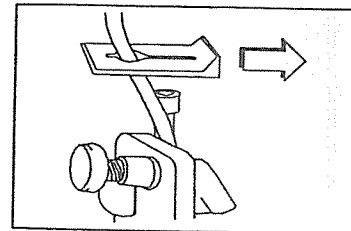

Open the upper clamp.

5.2.2 PRIMING THE CASSETTE

To prime the cassette, proceed as follows:

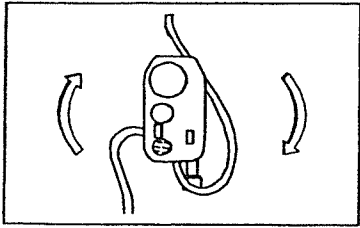

Invert the cassette.

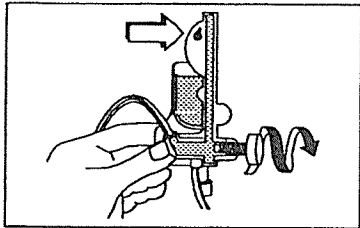

Turn the flow regulator until a drop of fluid is seen in the pumping chamber.

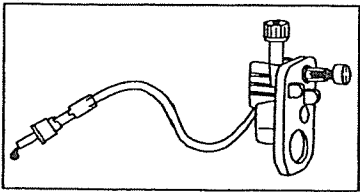

Turn the cassette upright, then prime the remainder of the administration set.

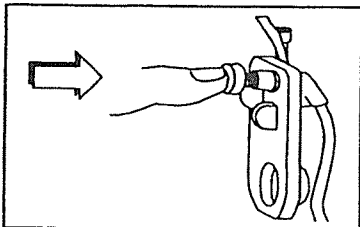

Push in the flow regulator to close it.

Confirm that there is no flow.

5.2.3 LOADING THE CASSETTE

To load the primed cassette into one of the three pumping units, proceed as follows:

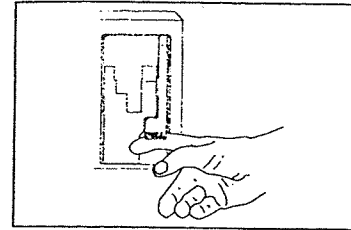

Open the cassette door by lifting the door handle.

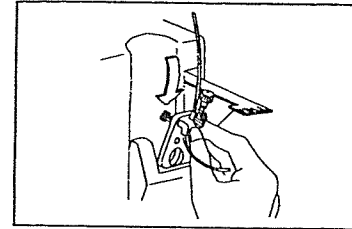

Holding the primed cassette by its fingergrip, slide it into the cassette door guides until it firmly seats in the door. Close the cassette door.

Confirm that there is no flow.

5.2.4 SECURING THE TUBING

WARNING

ARRANGE TUBING, CORDS, AND CABLES TO MINIMIZE THE RISK OF PATIENT STRANGULATION OR ENTANGLEMENT.

Press the tubing from the cassette into the grooves between the pumping units or into the grooves at the far sides of the platform under the pump modules (refer to the following illustrations).

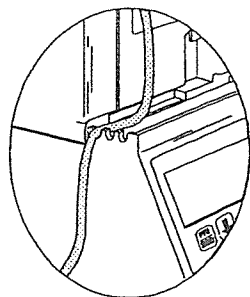
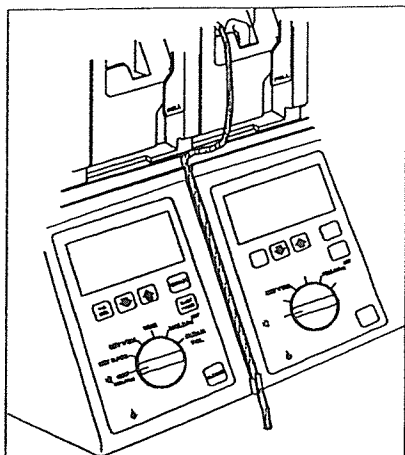

5.2.5 PREPARING THE SECONDARY LINE

CAUTION: Consult the drug container labeling to confirm drug compatibility, concentration, delivery rates, and volumes are all suitable for intermittent or continuous secondary, or piggyback delivery mode.

The Plum XL3 features a secondary or piggyback delivery mode when patient infusion therapy requires administering more than one drug through a single patient line.

In addition to standard containers, the Plum XL3 uses syringes or vials on the secondary port for piggyback or secondary delivery. The secondary line can be prepared without removing or repriming the cassette.

Before preparing the secondary line, observe the following guidelines:

- ❑ Review the backpriming function (see *Section 6.4, Backpriming*)
- ❑ Use sets with an appropriate secondary port
- ❑ Attach the secondary line, syringe, or vial to the appropriate secondary cassette inlet using an 18- or 19- gauge, 1-1/4 inch (or shorter) needle, blunt cannula, or male adapter
- ❑ *Syringes:* Attach the syringe adapter to syringes 10 cc or smaller (syringes must be larger than 3 cc)
- ❑ *Vials:* Attach the vial adapter to the secondary line vial

To prepare the secondary line, use aseptic technique and proceed as follows:

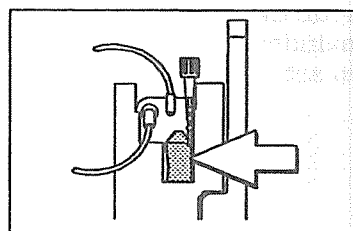

Confirm that the cassette air trap is full of fluid. If air is present, use the backpriming function to expel the air.

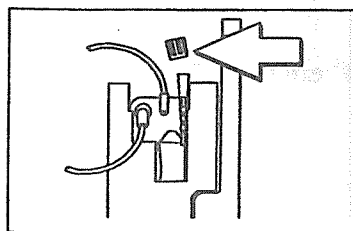

Remove the cap from the secondary inlet port (unless a reseal port is used).

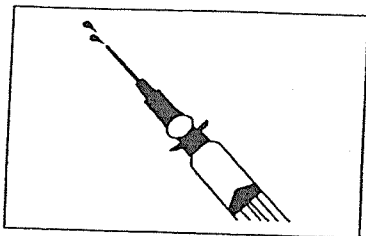

Syringe: Invert the syringe and expel the air (syringe adapter with blunt cannula is shown).

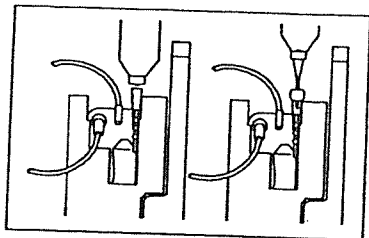

Attach the secondary container to the secondary inlet port (capped port shown on the left, preperced port on the right).

Syringe: When using a 3 to 5 cc syringe, retract the plunger to draw approximately 1 mL of air into the syringe to clear fluid from the adapter filter.

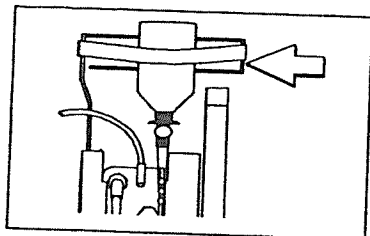

Vial or Syringe: Secure the container to the cassette door using the *optional* container support arm.

Vial: Attach the vial adapter to the secondary port. Backprime the air from the vial adapter into the vial, if necessary.

6.0 PROGRAMMING

The Plum XL3 Micro/Macro has the following delivery mode from each pumping unit, A, B, or C:

- Primary only delivery
- Secondary only delivery
- Piggyback delivery

When a rate and a VTBI are entered for the primary line and no settings are entered for the secondary line, the Plum XL3 will deliver primary only. Likewise, when a rate and a VTBI are entered for the secondary line and no settings are entered for the primary line, the Plum XL3 delivers secondary only. When a rate and a VTBI are entered for the primary and secondary lines (piggyback delivery), the Plum XL3 completes secondary delivery before it begins primary delivery.

Note: The Plum XL3 retains all previous therapy settings and fluid delivery data in its memory until the settings are cleared by the user. Check the primary and secondary settings during the initial setup to confirm that all settings are correct. Confirm the proper clearing of the total volume delivered before use.

6.1 Primary Only Delivery

To program the Plum XL3 for primary only delivery, proceed as follows:

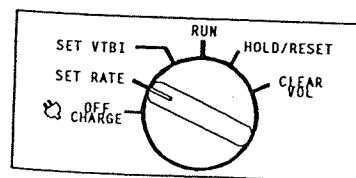

Turn the control dial to SET RATE.

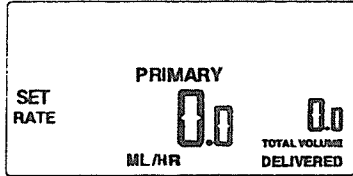

Press the [PRI-SEC] key to select the primary line (if it is not already selected).

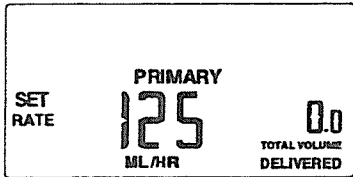

Press the or key, or the [QUICKSET] key to set the primary rate.

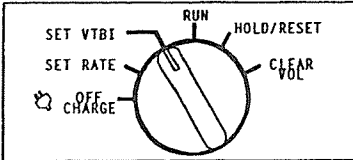

Turn the control dial to SET VTBI.

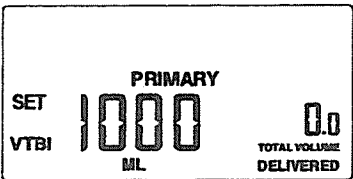

Press the or key, or the [QUICKSET] key to set the volume to be delivered.

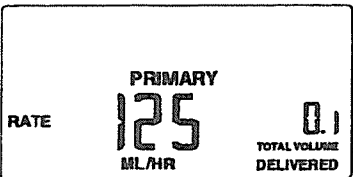

Turn the control dial to RUN. Primary only delivery begins.

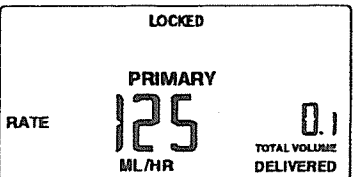

(Optional): Set the panel lockout switch to locked to prevent unauthorized tampering of the device (see Section 6.8, Lockout).

6.2 Secondary Only Delivery

To program the Plum XL3 for secondary only delivery, proceed as follows:

Note: Confirm that the primary rate and the VTBI are set to 0 (zero) before programming secondary only delivery.

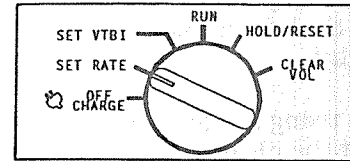

Turn the control dial to SET RATE.

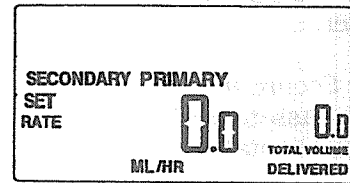

Press the [PRI-SEC] key to select the secondary line (if it is not already selected).

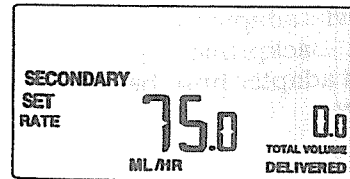

Press the or key, or the [QUICKSET] key to set secondary rate.

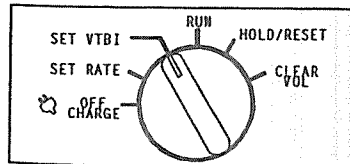

Turn the control dial to SET VTBI.

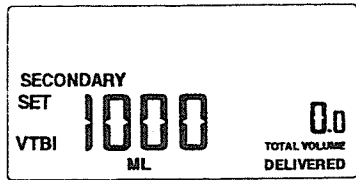

Press the or key, or the [QUICKSET] key to set the volume to be delivered.

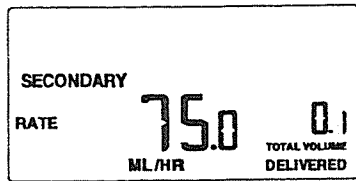

Turn the control dial to RUN. Secondary only delivery begins.

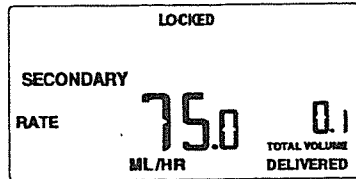

(Optional): Set the panel lockout switch to locked to prevent unauthorized tampering of the device (see Section 6.8, Lockout).

6.3 Piggyback Delivery

To program the Plum XL3 for piggyback delivery, proceed as follows:

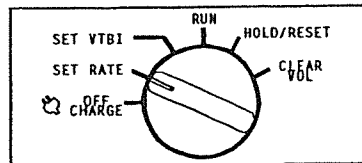

Turn the control dial to SET RATE.

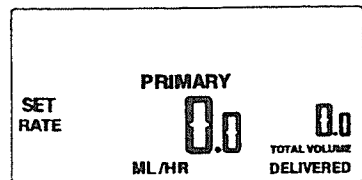

Press the [PRI-SEC] key to select the primary line (if it is not already selected).

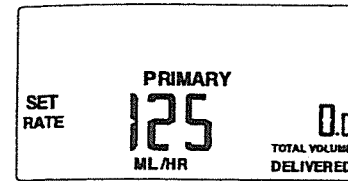

Press the or key, or the [QUICKSET] key to set the primary rate.

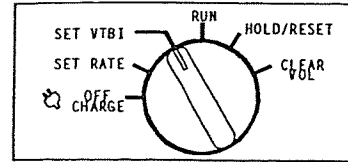

Turn the control dial to SET VTBI.

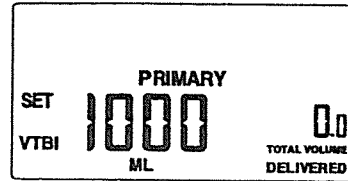

Press the or key, or the [QUICKSET] key to set the volume to be delivered.

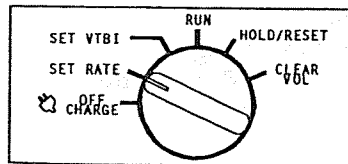

Turn the control dial to SET RATE.

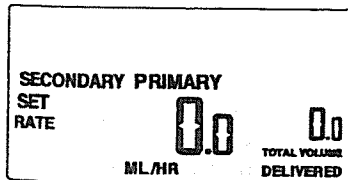

Press the [PRI-SEC] key to select the secondary line.

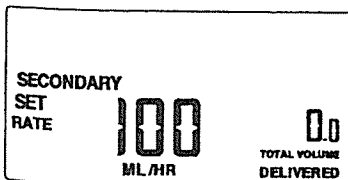

Press the or key, or the [QUICKSET] key to set the secondary rate.

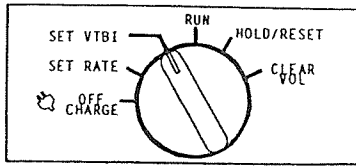

Turn the control dial to SET VTBI.

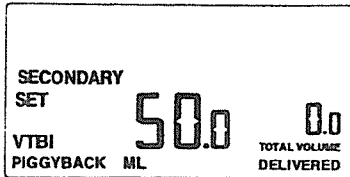

Press the or key to set the volume to be delivered. PIGGYBACK displays on the screen when the volume to be delivered is entered.

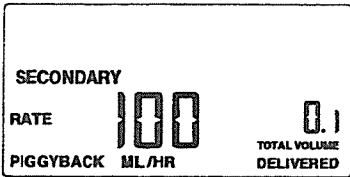

Turn the control dial to RUN. Piggyback delivery begins.

When secondary delivery completes, Plum XL3s with software revisions 1.02 and earlier beep five times and begin primary delivery.

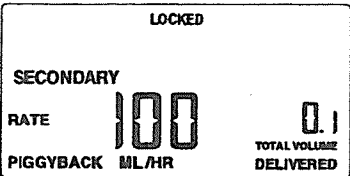

(Optional): Set the panel lockout switch to locked to prevent unauthorized tampering of the device (see *Section 6.8, Lockout*).

6.4 Backpriming

Backpriming is typically used to clear accumulated air from the cassette or to clear air from the secondary line without disconnecting the administration set from the patient. AIR IN LINE and BACKPRIMING display on the screen and an alarm sounds when air is detected in the cassette. Fluid is backprimed from the primary line up through the secondary inlet port to expel the air.

To expel air from the cassette when using primary delivery (secondary inlet port is capped or resealed), or when using piggyback delivery, proceed as follows:

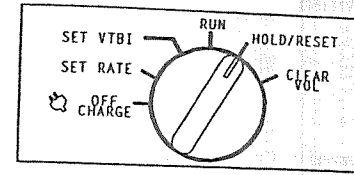

Turn the control dial to HOLD/RESET (the alarm is silenced).

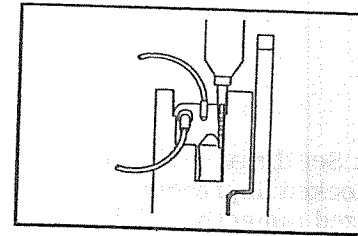

Primary only: Attach an empty container or syringe to the secondary inlet port (syringe shown).



Primary only: Press and hold the [BACKPRIME] key until enough fluid from the primary line expels the trapped air into the secondary container.



Piggyback: Press and hold the [BACKPRIME] key until enough fluid from the primary line expels the trapped air into the secondary line syringe or container.

Note: The fluid backprimed from the primary line is not added to the total volume delivered, or subtracted from the VTBI. Backpriming cannot be used for clearing air in the line distal to the cassette.

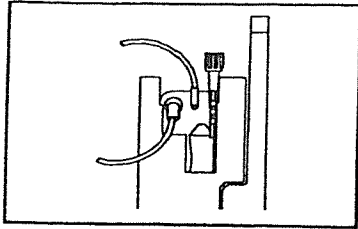

Primary only: Remove the container attached to the secondary inlet port, then cap the port (if appropriate).

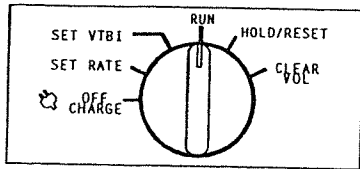

To resume delivery, turn the control dial to RUN.

6.5 Changing Containers

To change a container, use aseptic technique and proceed as follows:

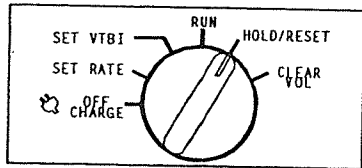

Turn the control dial to HOLD/RESET.

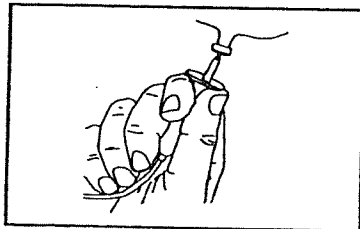

With the cassette door closed, spike the new container.

Note: If opening the cassette door, close the primary and secondary clamps before removing containers (to prevent mixing).

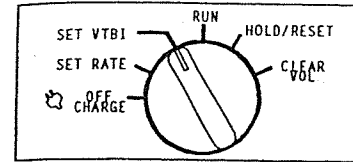

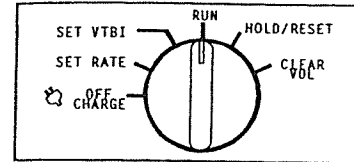

Turn the control dial to SET VTBI, then set the volume to be delivered.



To resume delivery, turn the control dial to RUN.

6.6 Titration

Titration is the incremental adjustment of the fluid delivery rate while pumping (primary or secondary) is in progress.

To titrate fluid delivery, hold down the [TITRATE] key and press the  or  key to increase or decrease the delivery rate.

6.7 Clear Volume

CLEAR VOL erases the total volume delivered from memory.

Note: The total volume delivered is the total amount of fluid, both primary and secondary, delivered to the patient.

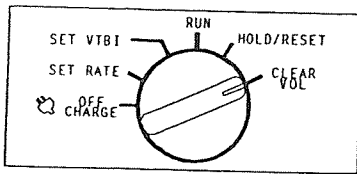

To clear the total volume, turn the control dial to CLEAR VOL. Four beeps sound before the total volume is cleared.

Note: To cancel the clear total volume function, turn the control dial away from the CLEAR VOL setting before the fourth beep sounds (e.g., turn the control dial to HOLD/RESET).

6.8 Lockout

To avoid unauthorized tampering of the Plum XL3, set the panel LOCKOUT switch to on. When the lockout switch is on, the word LOCKED appears on the LCD screen and the keys are inactive. If the control dial is moved, the LOCKED alarm will sound. To clear the alarm, set the LOCKOUT switch to off.

7.0 TROUBLESHOOTING

This section contains solutions to routine clinical conditions that may occur while using the Plum XL3 Micro/Macro that do not require assistance from hospital or Abbott Laboratories Technical Support Operations personnel.

Problems that may occur in the Plum XL3 are in two categories: alarms and malfunctions.

7.1 Alarms

During an alarm condition associated with one of the pumping units, the screen backlight and the alarm message flash, while an alarm sounds. To clear an alarm condition, proceed as follows:

SILENCE

Press the [SILENCE] key. Observe the alarm message that displays.

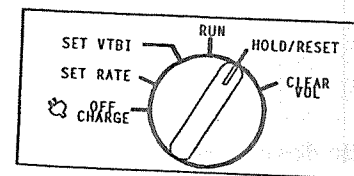

Turn the control dial to HOLD/RESET.

Correct the alarm condition.

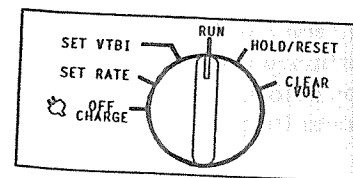

Turn the control dial to RUN.

The following tips help correct the alarm conditions that may occur:

MESSAGE	POSSIBLE CAUSE	CORRECTIVE ACTION
AIR IN LINE	Air detected distal to cassette	Remove and reprime cassette
AIR IN LINE BACKPRIMING	Air detected proximal to cassette	Backprime to expel all air
	Container empty	Change container and backprime to expel air
CHECK SETTINGS	Rate or VTBI not set	Turn to SET RATE or SET VTBI to check setting or enter values
DOOR	Cassette door open	Turn to OFF CHARGE, close cassette door, then restart
CASSETTE	Cassette improperly loaded	Turn to OFF CHARGE, reload cassette, then restart
	Cassette improperly primed	Turn to OFF CHARGE, reprime cassette, then restart
	Cassette failed valve leak test	Turn to OFF CHARGE, open and close cassette door, then restart. If condition recurs, replace PlumSet
LOCKED (flashing)	Control dial turned while lockout switch is on	Set lockout switch off. Set unit for desired operation. Set lockout switch on

MESSAGE	POSSIBLE CAUSE	CORRECTIVE ACTION
LOW BATTERY	Approximately 30 minutes of battery power remains	Connect to AC power
		<p>Note: Pressing the [SILENCE] key mutes the audible alarm for 15 minutes from the time the LOW BATTERY alarm occurred</p> <p>Note: When the battery discharges, pumping stops and the alarm sounds continuously for one minute before the device shuts down completely</p>
OCCLUSION	Clamp closed	Open clamps
	Tubing kinked	Unkink tubing
	Possible clotted catheter	Check IV site
TURN TO RUN	Control dial is not in OFF CHARGE or RUN setting and no key is pressed for five minutes	Turn control dial to RUN, OFF CHARGE, or HOLD/RESET

MESSAGE	POSSIBLE CAUSE	CORRECTIVE ACTION
VTBI COMPLETE	<p><i>Secondary Only, or Primary Only:</i> Programmed VTBI completed</p> <p><i>Piggyback:</i> Primary VTBI completed</p> <p>Note: KVO also displays on the screen indicating the KVO rate is in progress</p>	Discontinue infusion, or change container and program new VTBI setting

7.2 Malfunctions

During a malfunction associated with one of the pumping units, an "Er" and an error number display on the screen and the audible alarm sounds.

To verify the malfunction, proceed as follows:

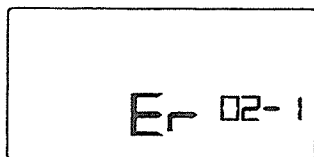

Record the error number displayed on the screen.

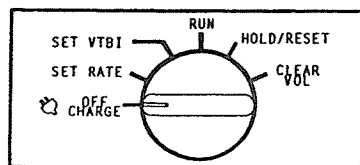

Turn the control dial to OFF CHARGE.

Turn the control dial to its previously set setting to retest the device. If the malfunction recurs, remove the Plum XL3 from service.

7.3 Technical Assistance

For technical assistance, technical training information, or to order parts, accessories, or manuals, contact Abbott Laboratories Technical Support Operations.

The telephone number for Technical Support Operations is:

1-800-241-4002

Send all authorized, prepaid returns to the following address:

Abbott Laboratories
 Technical Support Operations
 755 Jarvis Drive
 Morgan Hill, California 95037

Do not return the Plum XL3 without prior approval from Abbott Laboratories Technical Support Operations.

For technical assistance from outside the U.S., contact the nearest Abbott Laboratories representative.

NOTES

8.0 PRECAUTIONS

For optimum operation of the Plum XL3 Micro/Macro, observe the following precautions.

8.1 Artifacts

Nonhazardous, low level electrical potentials are commonly observed when fluids are administered using infusion devices. These potentials are well within accepted safety standards, but may create artifacts on voltage sensing equipment such as ECG, EMG, and EEG machines. These artifacts vary at a rate that is associated with the infusion rate. If the monitoring machine is not operating correctly or has loose or defective connections to its sensing electrodes, these artifacts may be accentuated so as to simulate actual physiological signals. To determine if the abnormality in the monitoring equipment is caused by the infusion device instead of some other source in the environment, set the infusion device so that it is temporarily not delivering fluid. Disappearance of the abnormality indicates that it was probably caused by the electronic noise generated by the infusion device. Proper setup and maintenance of the monitoring equipment should eliminate the artifact. Refer to the appropriate monitoring equipment system documentation for setup and maintenance instructions.

8.2 Healthcare Professional and Patient Related

Product checkout should be performed by qualified personnel only.

Arrange tubing, cords, and cables to minimize the risk of patient strangulation or entanglement.

Consult the drug container labeling to confirm drug compatibility, concentration, delivery rates, and

volumes are all suitable for intermittent or continuous secondary or piggyback delivery mode.

Setting the primary rate greater than the secondary rate will result in a more rapid infusion of any residual secondary drug remaining in the line and the cassette.

Before disconnecting a syringe from the cassette, pull up the plunger slightly to avoid spilling the fluid. For rigid containers (e.g., vials), open the cassette door, remove and invert the cassette (ports down). Close the upper slide clamp of the set before removing the container (to minimize spilling of fluid during replacement of the container).

In vitro studies have suggested that packed red blood cells with unusually high hematocrit be diluted with blood-compatible fluids, such as 0.9% Sodium Chloride Injection, USP, to decrease hemolysis and increase flow rate.

A small amount of fluid is expelled from the set (less than 0.1 mL) each time the door is opened or closed with a set installed. If potent drugs are being used, take appropriate action to guard against overmedication of the patient.

Before opening a cassette door, close the clamp on the secondary set or remove the secondary container from the secondary port of that pumping unit to prevent mixing of primary and secondary fluids.

Repeated opening and closing of a cassette door may defeat the proximal AIR IN LINE alarm and may cause an AIR IN LINE alarm, requiring cassette repriming. Repeated opening and closing of a door may also cause the drip chamber to fill.

8.3 Battery Operation

CAUTION: Do not operate the Plum XL3 with the battery removed. The use of a properly maintained and charged battery ensures proper operation. As always, in the event of an AC power interruption or failure, verify infusion pump settings.

The battery may not be fully charged upon receipt. Connect the Plum XL3 to AC power for at least six hours with the control dial in the OFF CHARGE setting.

If the LOW BATTERY alarm sounds, connect to AC power immediately.

8.4 Sets and Accessories

Only PlumSets administration sets can be used with this device.

Sets should be changed in accordance with current, recognized guidelines of IV therapy. Discard sets per hospital procedures.

LifeCare IV infusion sets with integral nonblood filters are not for use in the administration of blood, blood products, emulsions, suspensions, or any medications not totally soluble in the solution being administered. These medications may be administered through the lower Y-injection site, below the filter.

When infusing at low delivery rates (5.0 mL/hr or less) the use of thick-walled microbore Plumsets is recommended. This will reduce the amount of the fluid bolus that may be delivered when a distal line occlusion is released.

Use the syringe adapter when using syringes 10 cc or smaller on the secondary line (syringes must be larger than 3 cc).

Use 19-gauge or larger needle or catheter for viscous fluids if operating at rates greater than 500 mL/hr. Use a cassette with a capped secondary port when delivering viscous fluids on the secondary line.

8.5 Backpriming

Backpriming is not recommended for reconstituting secondary containers containing dry powders.

To avoid pressurization when backpriming into a syringe or a vial, the user must ensure that these containers have sufficient empty space to accept the backprimed fluid.

8.6 General

Possible explosion hazard exists if used in the presence of flammable anesthetics.

Product damage may occur unless proper care is exercised during unpacking and installation. Do not use the Plum XL3 if it appears damaged in any way.

Do not place Plum XL3 in service if it fails the self-test (see *Section 3.2, Self-Test* for detailed information).

The XL3 system is designed to operate normally in the presence of most encountered EMF conditions. In the event of extreme levels of interference, such as encountered next to an electrosurgical generator, cellular telephones, or two-way radios, it is possible that the normal operation of a sensor or microcomputer might be disrupted. Operation of the infusion device under such conditions should be avoided.

The screen displays VTBI in 0.1-mL increments from 0.1 to 99.9 mL. 100 to 9999 mL are displayed in 1-mL increments. Any fraction of a milliliter delivered is not displayed, but is retained in memory.

Keep the cassette door securely closed while the Plum XL3 is not in use, to avoid cassette door damage.

To avoid mechanical or electronic damage, do not immerse the Plum XL3 in any cleaning fluids or cleaning solutions.

Certain cleaning and sanitizing compounds may slowly degrade components made from some plastic materials. Using abrasive cleaners or cleaning solutions not

recommended by Abbott Laboratories may result in product damage. Do not use compounds containing combinations of isopropyl alcohol and dimethyl benzyl ammonium chloride.

Never use sharp objects such as fingernails, paper clips, or needles to clean any part of the Plum XL3.

Do not sterilize by heat, steam, ethylene oxide (ETO), or radiation.

To avoid device damage, cleaning solutions should be used only as directed in *Section 9.1, Cleaning and Sanitizing*. The disinfecting properties of cleaning solutions vary; consult the manufacturer for specific information.

NOTES

9.0 CLEANING, MAINTENANCE, AND STORAGE

The cleaning, maintenance, and storage of the Plum XL3 Micro/Macro are described in this section.

9.1 Cleaning and Sanitizing

For proper maintenance of the Plum XL3, observe the following cleaning and sanitizing guidelines.

CAUTIONS:

To avoid mechanical or electronic damage, do not immerse the Plum XL3 in any cleaning fluids or cleaning solutions.

Certain cleaning and sanitizing compounds may slowly degrade components made from some plastic materials. Using abrasive cleaners or cleaning solutions not recommended by Abbott Laboratories may result in product damage. Do not use compounds containing combinations of isopropyl alcohol and dimethyl benzyl ammonium chloride.

Never use sharp objects such as fingernails, paper clips, or needles to clean any part of the Plum XL3.

Do not sterilize by heat, steam, ethylene oxide (ETO), or radiation.

To avoid device damage, cleaning solutions should be used only as directed in the following table. The disinfecting properties of cleaning solutions vary; consult the manufacturer for specific information.

Establish a routine weekly schedule for cleaning the Plum XL3. To clean the Plum XL3, proceed as follows:

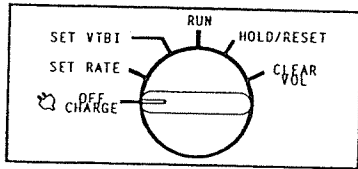

Turn the control dial to OFF CHARGE, then disconnect the Plum XL3 from AC power.

Use the recommended LifeCare Germicidal Towelette to clean the exposed surfaces of the Plum XL3. The exposed surfaces of the Plum XL3 may also be cleaned with a lint-free cloth dampened with one of the other recommended cleaning solutions listed as follows or mild, nonabrasive soapy water.

Note: The Abbott LifeCare Germicidal Towelette (List 11937) is a pre-moistened wipe containing a quaternary ammonium chloride germicidal detergent. The towelette has been found to be effective against a broad spectrum of bacterial, fungal, and viral pathogens. For additional information on the LifeCare Germicidal Towelette, call Abbott Customer Service 1-800-ABBOTT3 (1-800-222-6883).

Cleaning Solution	Manufacturer	Preparation
LifeCare® Germicidal Towelette (subject to availability)	Manufactured for Abbott Laboratories	Per manufacturer's recommendation
Super Edisonite®	S. M. Edison Co.	Per manufacturer's recommendation
Vesphene II® se	Calgon Vestal Laboratories	Per manufacturer's recommendation
Manu-Klenz®	Calgon Vestal Laboratories	Per manufacturer's recommendation
Formula C™	Diversey Corporation	Per manufacturer's recommendation
Household bleach	Various	Per hospital procedures; do not exceed one part bleach in ten parts water

On a routine basis, clean all of the elements behind the cassette doors using LifeCare Germicidal Towelettes or cotton-tipped swabs saturated with cleaning solution. The cassette doors may be unlatched from their door handles to facilitate cleaning.

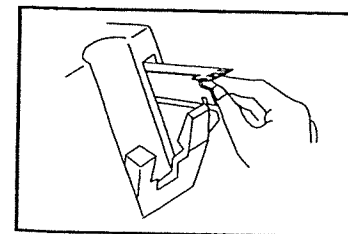

To unlatch a cassette door from its handle, tilt the device back, open the cassette door, then push the door release tab to open the door fully.

9.2 Battery Maintenance

CAUTION: Do not operate the Plum XL3 with the battery removed. The use of a properly maintained and charged battery ensures proper operation. As always, in the event of an AC power interruption or failure, verify infusion pump settings.

CAUTION: If the LOW BATTERY alarm sounds, connect the Plum XL3 to AC power immediately.

The Plum XL3 is battery powered for emergency backup and temporary portable operation. It should be operated on battery power until full discharge at least once every six months for optimum battery performance and life. A fully charged battery set will provide operating time of approximately four hours when all pumping units operate simultaneously at a rate of 125 mL/hr or a cumulative delivery of 1,000 mL at any combination of rates and pumping units.

The battery charges whenever Plum XL3 is connected to AC power. If all Plum XL3 pumping units are turned to OFF CHARGE, recharge takes approximately six hours. Recharge takes longer if the pumping units are turned on.

As a general rule, the more often the battery is partially discharged and recharged, the sooner it will need to be replaced. Consult a qualified hospital biomedical technician for battery replacement if necessary.

To maintain maximum battery charge and to prolong battery life, keep the line cord connected to AC power whenever possible.

9.3 Storage

To prolong the life of the Plum XL3, observe the following guidelines:

- Turn the control dial to the OFF CHARGE setting
- Store the Plum XL3 away from excessive heat, cold, and humidity
- Store the Plum XL3 connected to AC power

9.4 Service

All servicing or adjustments to the Plum XL3 should be referred to qualified technical personnel. A Technical Service Manual may be ordered from Abbott Laboratories Technical Support Operations.

NOTES

10.0 SYSTEM ACCESSORIES

Plum XL3 Micro/Macro is compatible with all Plum accessories, and all PlumSets administration sets.

Note: Accessories are updated without notice. Contact an Abbott Laboratories Hospital Products representative for current listings.

11.0 SPECIFICATIONS

PHYSICAL:

Dimensions: Approximately 13.75H x 12.2W x 7.5D inches (excluding pole clamp)

Weight: Approximately 20 lbs (with batteries)

Casing: High-impact plastic

ELECTRICAL:

Power Requirements: 100-130 VAC, 47/63 Hz, less than 60 W

Power Cord: Hospital-grade AC cord, 10 ft long

Fuses: 1.0 A, 250 V, Slow Blowing

Batteries: Rechargeable and sealed, lead-acid 8 V batteries which are internal to the device. Accessible for ease of field replacement with leads and polarized connectors.

Battery Life: The Plum XL3 is battery powered for emergency backup and temporary portable operation. It should be operated on battery power until full discharge at least once every six months for optimum battery performance and life. A fully charged battery set will provide operating time of approximately four hours when all pumping units operate simultaneously at a rate of 125 mL/hr or a cumulative delivery of 1,000 mL at any combination of rates and pumping units.

Recharge: The batteries charge whenever the Plum XL3 Micro/Macro is connected to AC power. If the device pumping units are turned to OFF CHARGE, recharge takes approximately six hours. Recharge takes longer if the pumping units are turned on.

ENVIRONMENT:

Operating Temperature: 10° to 40° C, 10% to 90% relative humidity

TRANSPORT AND STORAGE

ENVIRONMENT:

Temperature: -20° to 60° C

Relative Humidity: 10% to 90%

Atmospheric Pressure: 0-10,000 feet (0-3,000m) or equivalent pressure

DELIVERY RATE RANGE:

Primary, Secondary Mode: 0.1 to 99.9 mL/hr (in 0.1-mL increments)

100 to 999 mL/hr (in 1 mL increments)

KVO: The lower of 1.0 mL/hr or the primary delivery rate

DOSE LIMIT RANGE:

Primary, Secondary Mode: 0.1 to 99.9 mL (in 0.1-mL increments)

100 to 9999 mL (in 1-mL increments)

OCCLUSION RANGE:

Distal: 10 psig (+5, -2 psig)

12.0 WARRANTY

Subject to the terms and conditions herein, Abbott Laboratories, herein referred to as Abbott, warrants that (a) the product shall conform to Abbott's standard specifications and be free from defects in material and workmanship under normal use and service for a period of one year after purchase, and (b) the replaceable batteries shall be free from defects in material and workmanship under normal use and service for a period of 90 days after purchase. Abbott makes no other warranties, express or implied, as to merchantability, fitness for a particular purpose, or any other matter.

Purchaser's exclusive remedy shall be, at Abbott's option, the repair or replacement of the product. In no event shall Abbott's liability arising out of any cause whatsoever (whether such cause be based in contract, negligence, strict liability, other tort or otherwise) exceed the price of such product, and in no event shall Abbott be liable for incidental, consequential, or special damages or losses or for lost business, revenues, or profits. Warranty product returned to Abbott must be properly packaged and sent freight prepaid.

The foregoing warranty shall be void in the event the product has been misused, damaged, altered, or used other than in accordance with product manuals so as, in Abbott's judgment, to affect its stability or reliability, or in the event the serial or lot number has been altered, effaced, or removed.

The foregoing warranty shall also be void in the event any person, including the Purchaser, performs or attempts to perform any major repair or other service on the product without having been trained by an authorized representative of Abbott and using Abbott documentation and approved spare parts. For purposes

of the preceding sentence, "major repair or other service" means any repair or service other than the replacement of accessory items such as batteries and detachable AC power cords.

In providing any parts for repair or service of the product, Abbott shall have no responsibility or liability for the actions or inactions of the person performing such repair or service, regardless of whether such person has been trained to perform such repair or service. It is understood and acknowledged that any person other than an Abbott representative performing repair or service is not an authorized agent of Abbott.

NOTES

For customer service within the United States, contact:

1-800-ABBOTT3 (1-800-222-6883)

For technical assistance and product return authorization within the United States, contact:

1-800-241-4002

After authorization, ship prepaid product returns to the following address:

Abbott Laboratories
Technical Support Operations
755 Jarvis Drive
Morgan Hill, CA 95037

Note: Outside the U.S., contact your local Abbott Laboratories sales office.

CAUTION: Federal (USA) law restricts this device to sale by or on the order of a physician or other licensed practitioner.

WARNING

A POSSIBLE EXPLOSION HAZARD EXISTS IF THE DEVICE IS USED IN THE PRESENCE OF FLAMMABLE ANESTHETICS.

Patents Pending

Plum, PlumSets, LifeShield, and LifeCare are registered trademarks of Abbott Laboratories. Plum XL3 and Quickset are trademarks of Abbott Laboratories. Formula C is a trademark of Diversey Corporation. Manu-Klenz and Vesphene II se are registered trademarks of Calgon Vestal Laboratories. Super Edisonite is a registered trademark of S.M.Edison Chemical Co.



NRTL/C
CSA 22.2/
No. 125
UL 544

CSA is a registered trademark of the Canadian Standards Association. The use of NRTL/C adjacent to the CSA mark indicates that the product has been certified by CSA to U.S. and Canadian standards. CSA has been accredited by the U.S. Occupational Safety and Health Administration (OSHA), as a Nationally Recognized Test Laboratory (NRTL).